

Service Manual



SRS property

REPAIR & ADJUSTMENTS



**ORDER NO.
ARP-294-0**

AM/FM STEREO RECEIVER

SX-50

KU

MODEL SX-50 COMES IN FOUR VERSIONS DISTINGUISHED AS FOLLOWS:

Type	Voltage	Remarks
KU	AC120V only	U.S.A. model
KC	AC120V only	Canada model
S	AC110V, 120V, 220V, 240V (switchable)	General export model
S/G	AC110V, 120V, 220V, 240V (switchable)	U.S. Military model

- This service manual is applicable to the KU type.
For servicing of the other types, please refer to the additional service manual.
- For the circuit description, please refer to the SX-60, SX-50, SX-40 service manual (ARP-393-0).
- Ce manuel d'instruction se réfère au mode de réglage, en français.
- Este manual de servicio trata del método de ajuste escrito en español.

CONTENTS

1. SPECIFICATIONS	2	7. ELECTRICAL PARTS LIST	20
2. FRONT PANEL FACILITIES	3	8. PACKING	23
3. PARTS LOCATION	5	9. ADJUSTMENT	24
4. EXPLODED VIEW AND PARTS LIST	7	RÉGLAGE	26
5. P.C. BOARDS CONNECTION DIAGRAM	11	AJUSTE	28
6. SCHEMATIC DIAGRAM	15	10. SAFETY INFORMATION	30

PIONEER ELECTRONIC CORPORATION 4-1, Meguro 1-Chome, Meguro-ku, Tokyo 153, Japan
PIONEER ELECTRONICS (USA) INC. 1925 E. Dominguez St., Long Beach, California 90810 U.S.A.
PIONEER ELECTRONIC (EUROPE) N.V. Keetberglaan 1, 2740 Beveren, Belgium
PIONEER ELECTRONICS AUSTRALIA PTY. LTD. 178-184 Boundary Road, Braeside, Victoria 3195, Australia

FX © JUNE 1983 Printed in Japan

1. SPECIFICATIONS

Power Amplifier Section

Continuous Average Power Output is 50 watts* per channel, min., at 8 ohms from 20 Hertz to 20,000 Hertz with no more than 0.007% total harmonic distortion.**

Intermodulation Distortion (50 Hertz : 7,000 Hertz = 4:1, 8 ohms, from POWER IN)

continuous rated power output: No more than 0.007%

Pre Amplifier Section

Input (Sensitivity/Impedance)

PHONO MM 2.5mV/50 kilohms
 CD/AUX, VIDEO, TAPE PLAY . . . 150mV/50 kilohms

Phono Overload Level (T.H.D. 0.1%, 1,000 Hertz) . . REC OUT

PHONO MM 130mV

Output (Level/Impedance)

TAPE REC 1, 2, ADAPTOR OUT . . 150mV/2.2 kilohms

Frequency Response

PHONO (RIAA Equalization)
 20Hz to 20,000 Hertz \pm 0.3dB
 CD/AUX, VIDEO, TAPE PLAY
 5Hz to 100,000 Hertz $^{+0}_{-3}$ dB

Tone Control

BASS \pm 8dB (100Hz)
 TREBLE \pm 8dB (10kHz)

Subsonic Filter 20Hz (6dB/oct.)

Loudness Contour (Volume control set at -40dB position)
 +6dB (100Hz)

Hum and Noise (IHF, short-circuited, A network)

PHONO MM 80dB
 CD/AUX, VIDEO, TAPE PLAY 95dB

FM Tuner Section

Usable Sensitivity . . Mono; 10.8dBf, IHF (0.95 μ V, 75 ohms)

50dB Quieting Sensitivity
 Mono; 17.3dBf, IHF (2 μ V, 75 ohms)
 Stereo; 37.5dBf, IHF (20 μ V, 75 ohms)

Signal-to-Noise Ratio Mono; 79dB (at 60dBf)
 Stereo; 75dB (at 80dBf)

Distortion

MONO	100Hz	0.1%
	1kHz	0.1%
	6kHz	0.25%
STEREO	100Hz	0.2%
	1kHz	0.15%
	6kHz	0.4%

Capture Ratio 1.0dB

Alternate Channel Selectivity 400kHz; 65dB

Stereo Separation 1kHz; 45dB
 30Hz to 15kHz; 35dB

Frequency Response 20Hz to 15kHz $^{+0.5}_{-1}$ dB

Spurious Response Ratio 70dB

Image Response Ratio 50dB

Auto Tuning Threshold 29.3dBf (8 μ V, 75 ohms)

Antenna Input . . 300 ohms balanced, 75 ohms unbalanced

AM Tuner Section

Sensitivity (IHF, Loop antenna) 220 μ V/m
 (IHF, Ext. antenna) 10 μ V

Selectivity 60dB

Signal-to-Noise Ratio 50dB

Antenna High sensitivity loop antenna

Miscellaneous

Power Requirements AC 120V, 60Hz

Power Consumption 240W

Dimensions 420(W) x 120(H) x 311(D) mm
 16-9/16(W) x 4-3/4(H) x 12-1/4(D) in

Weight (without package) 7.2kg (15 lb 14 oz)

Furnished Parts

FM T-type Antenna 1

AM Loop Antenna 1

Operating Instructions 1

* Measured pursuant to the Federal Trade Commission's Trade Regulation rule on Power Output Claims for Amplifier.

** Measured by Audio Spectrum Analyzer.

NOTE:

Specifications and the design subject to possible modifications without notice due to improvements.

2. FRONT PANEL FACILITIES

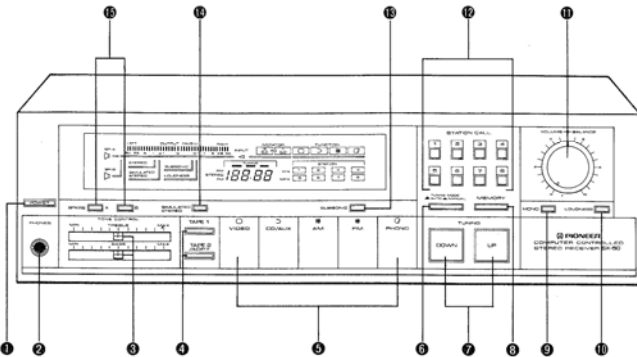

1 POWER SWITCH

Power is supplied to the unit when this switch is depressed. To turn off the power, release the switch.

2 PHONES JACK

Plug the headphones into this jack when you want to listen to a performance alone.

- When listening through the headphones alone, set both SPEAKERS SWITCHES A and B to OFF.

3 TONE CONTROL

This control is used to adjust the tone quality.

BASS Use this control to adjust the bass of the sound.

When the control is moved from the central position towards "MIN", the bass is attenuated and when it is moved towards "MAX", the bass is emphasised.

TREBLE . . Use this control to adjust the treble of the sound.

When the control is moved from the central position towards "MIN", the treble is attenuated and when it is moved towards "MAX", the treble is emphasised.

4 TAPE MONITOR SWITCHES

Use these switches when playing back tapes or monitoring a recording. There are tape terminals for two systems on

this receiver. Two tape decks can be attached and recording or playback performed. The two tape decks can also be used for recording simultaneously or for copying from one tape to another (but only from tape deck 1 to tape deck 2).

TAPE 1 . . . Press when performing with a tape deck connected to the TAPE 1 jacks on the rear panel. Also, press when copying a tape from tape deck 1 to tape deck 2.

TAPE 2 . . . Press when performing with a tape deck or other adaptor connected to the TAPE 2 jacks on the rear panel.

5 FUNCTION SWITCHES

VIDEO SWITCH:

Press this switch when listening to a video unit such as a VCR or laser disc player.

CD/AUX SWITCH:

Press this switch when listening to a compact disc player (CD player) or TV tuner connected to the CD/AUX jacks on the rear panel.

AM SWITCH:

Press this switch for AM reception.

FM SWITCH:

Press this switch for FM reception.

PHONO SWITCH:

Press this switch when listening to a record on a turntable connected to the PHONO jacks on the rear panel.

6 TUNING MODE SWITCH

This switch is used to select either AUTO search or MANUAL tuning.

■ AUTO (released position):

When the TUNING switch is depressed, The broadcasting stations are automatically scanned. Once a station has been found, the scanner stops at that frequency. To listen to another station, depress the TUNING switch once again and the procedure is repeated. The procedure stops as soon as another station is found.

■ MANUAL (depressed position):

For normal manual tuning.

Depress the TUNING switch and tune in to the desired station manually.

NOTES:

- If the broadcasting station is distant and its signals weak, you may not be able to find the station with AUTO tuning. In such an event, tune in to the desired station using MANUAL mode (■ depressed position).
- If the AUTO mode stops frequently when trying to tune into an AM broadcast because of city interference or weak nighttime stations, tune in using the MANUAL mode (■ depressed position).

7 TUNING SWITCHES

These are used to select the broadcasting station.

During MANUAL tuning, if the TUNING switch is depressed once, the frequency changes one step at a time. If the TUNING switch is kept depressed, the frequency changes continuously.

NOTE:

If you have connected an outdoor AM antenna, during AUTO SEARCH tuning, the AUTO SEARCH mechanism may stop near to, but not directly on, the frequency of stations with very powerful broadcasting waves.

8 MEMORY SWITCH

This switch is used to preset the broadcasting stations into the STATION CALL switches.

When this switch is depressed, the STATION indicators light up from 1 to 8 in sequence. To preset the station, press the STATION CALL switch when the indicator lights up.

9 MONO SWITCH

This switch is depressed to mix the L and R channel stereo input signals and listen to them in mono through both the left and right speakers.

10 LOUDNESS SWITCH

When listening to a performance with the VOLUME level is low, depress this switch and the bass will be accentuated.

When the volume is low, the human ear finds it harder to hear the bass and treble than when the volume is high. The LOUDNESS switch is thus designed to compensate for this deficiency.

11 VOLUME/BALANCE CONTROL

The inside knob is the VOLUME control and the outside knob the BALANCE control.

VOLUME:

This control is used to adjust the volume of the speakers and headphones. To increase the output level, turn the knob slowly clockwise (↻).

BALANCE:

This control is used to balance the volume of the left and right channels. If the sound appears to be weaker from the right speaker, turn the BALANCE control clockwise (↻). If the sound is weaker from the left speaker, turn the control counter-clockwise (↺).

NOTE:

When operating the VOLUME control, be careful not to turn the BALANCE control at the same time.

12 STATION CALL SWITCHES

Once the broadcasting stations are preset to these STATION CALL switches, the desired station can be received merely by pressing the appropriate switch, and without having to operate the TUNING switch each time.

13 SUBSONIC SWITCH

When this switch is depressed, the subsonic filter operates. The filter attenuates frequencies lower than 20Hz by 6dB/Oct and can be used to suppress the ultra low range noise generated by record warp and other factors. This noise cannot actually be heard by the ear, but it can cause intermodulation distortion and even damage to the speaker systems. Use therefore as required.

14 SIMULATED STEREO SWITCH

This turns monaural signals into simulated stereo sound. Use this when you wish to experience the sense of stereo presence with AM broadcasts, VCR or other monaural signal sources.

NOTE:

This function can also be used with stereo sources, but it will result in a different sound from the normal stereo sound.

15 SPEAKERS SWITCHES

Depress the switch corresponding to the speakers connected to the SPEAKERS terminals (A and B) on the rear panel. "A" refers to the speakers which have been connected to the A SPEAKERS terminals, while "B" refers to the speakers which have been connected to the B SPEAKERS terminals.

NOTE:

No sound will be heard through the speakers when both A and B switches are depressed if only one set of speakers has been connected to either A or B SPEAKERS terminals.

3. PARTS LOCATION

NOTES:

- The Δ mark found on some component parts indicates the importance of the safety factor of the part. Therefore, when replacing, be sure to use parts of identical designation.
- For your Parts Stock Control, the fast moving items are indicated with the marks ** and *.
- ** GENERALLY MOVES FASTER THAN *
- This classification shall be adjusted by each distributor because it depends on model number, temperature, humidity, etc.

Front Panel View

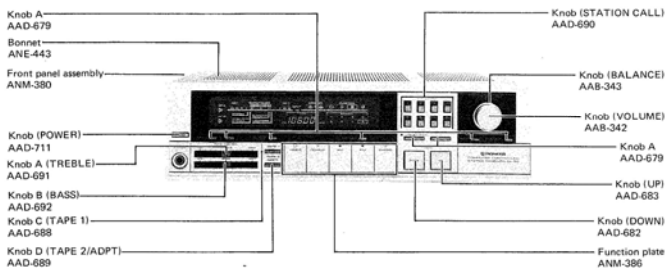

Front View

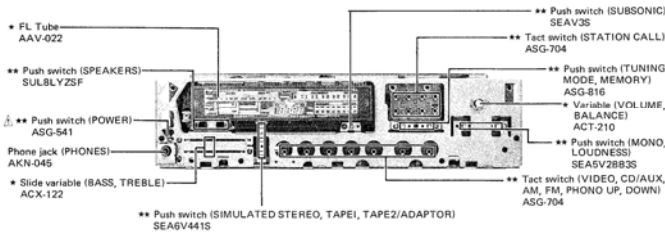

Top View

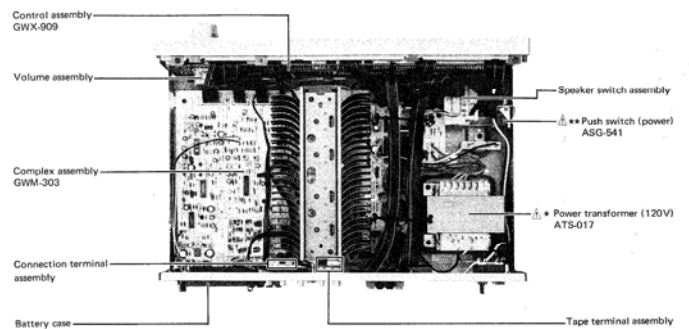

Rear View

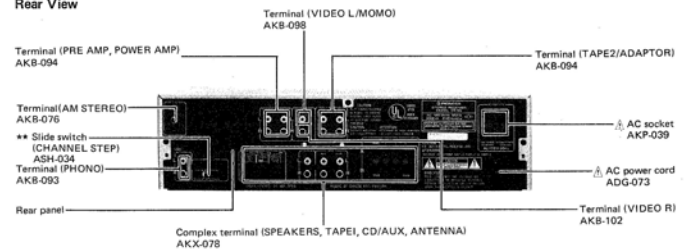

4. EXPLODED VIEW AND PARTS LIST

NOTES:

- Parts without part number cannot be supplied.
 - The ⚠ mark found on some component parts indicates the importance of the safety factor of the part. Therefore, when replacing, be sure to use parts of identical designation.
 - For your Parts Stock Control, the fast moving items are indicated with the marks ** and *.
- ★★ **GENERALLY MOVES FASTER THAN ***
 This classification shall be adjusted by each distributor because it depends on model number, temperature, humidity, etc.

Exterior Components

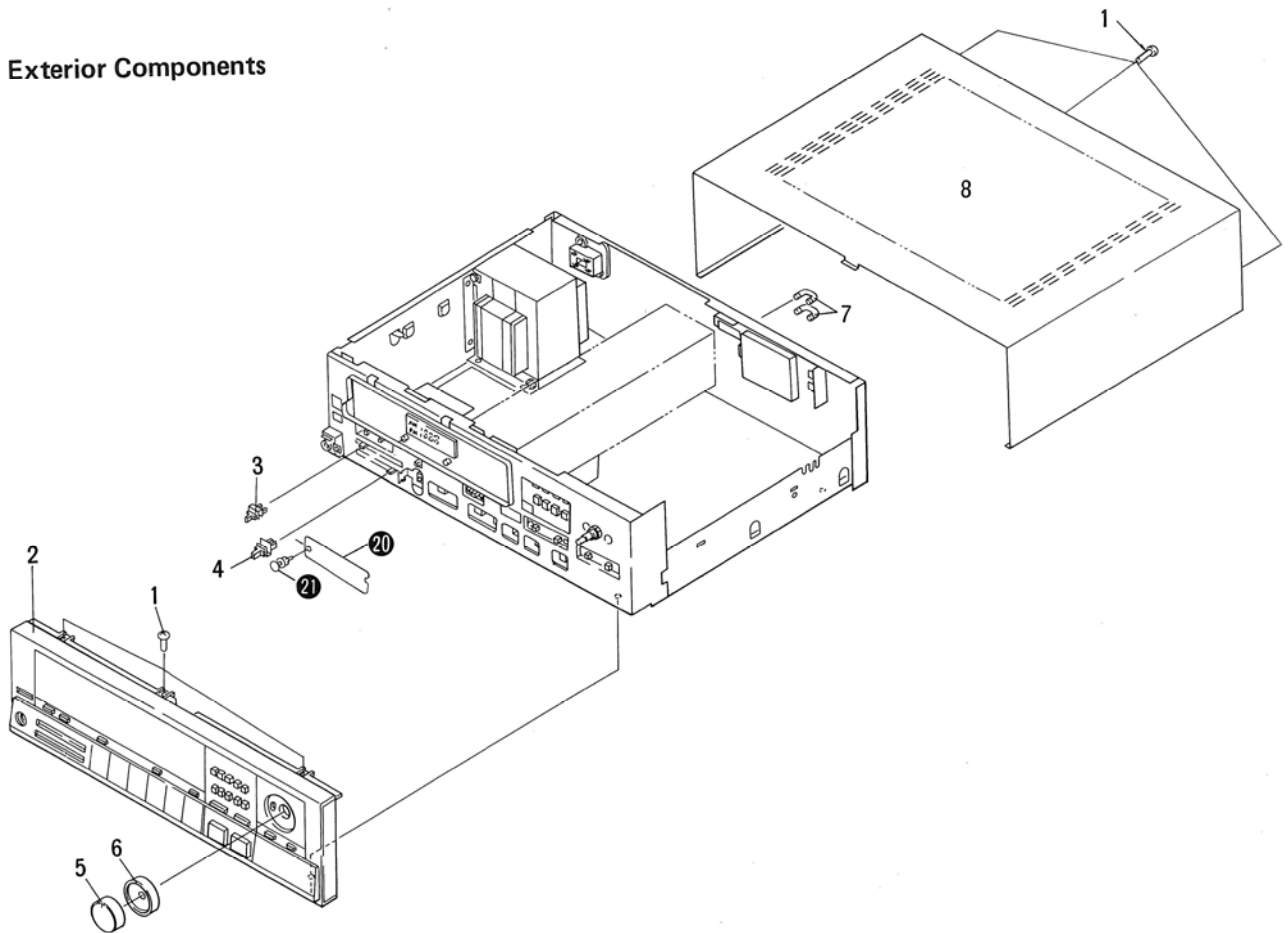

Parts List

Mark	No.	Part No.	Description	Mark	No.	Part No.	Description
	1	BBZ30P080FZK	Screw (3 x 8)		6	AAB-343	Knob (BALANCE)
	2	ANM-380	Front panel assembly		7	AKM-041	Connection plug
	3	AAD-691	Knob A (TREBLE)		8	ANE-443	Bonnet
	4	AAD-692	Knob B (BASS)		20		Masking sheet
	5	AAB-342	Knob (VOLUME)		21		Rivet

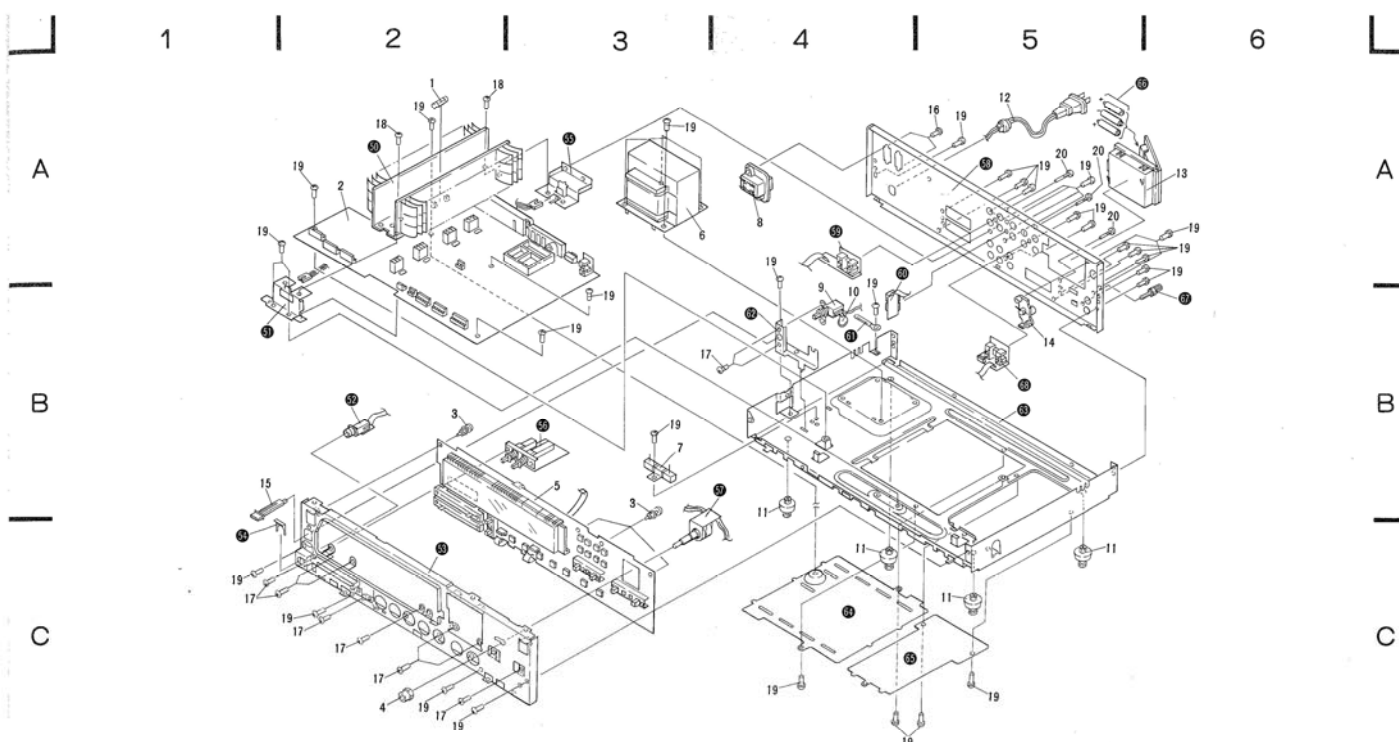

Parts List

Mark	No.	Part No.	Description	Mark	No.	Part No.	Description	Mark	No.	Part No.	Description
△	**	1	AEK-125		11	AEP-007	Bumper		60		Heat sink assembly
		2	GWM-303	△	12	ADG-073	AC power cord		61		Heat sink holder
		3	AEC-352		13	AKC-019	Battery case		62		Headphone jack assembly
		4	ABN-080		14	AKB-076	Terminal (AM STEREO)		63		Front panel holder
		5	GWX-609		15	AAD-711	Knob (POWER)		64		Mounting plate
△	*	6	ATS-017		16	MTZ30P100FZK	Screw (3 × 10)		65		Heat sink holder
		7	ACN-147		17	VMZ30P060FMC	Screw (3 × 6)		66		Speaker switch assembly
		8	AKP-039		18	VBZ30P100FMC	Screw (3 × 10)		67		Volume assembly
△	**	9	ASG-541		19	BBZ30P080FZK	Screw (3 × 8)		68		Rear panel
△	*	10	ACG-502		20	ABA-176	Screw		69		Tape terminal assembly
											Video terminal assembly
											Wire holder
											Switch holder
											Chassis
											Bottom plate A
											Bottom plate B
											Battery
											Terminal (GND)
											Connection terminal assembly

A

B

C

D

Heat Sink Assembly

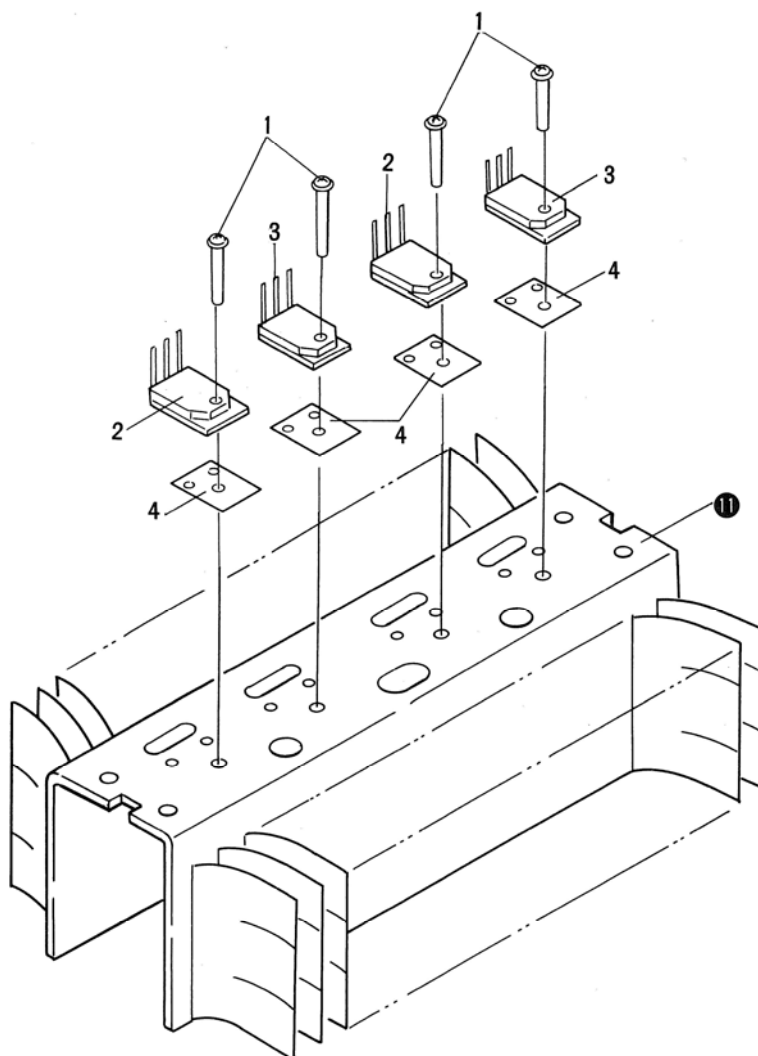

Parts List

Mark	No.	Part No.	Description
	1	ABA-258	Screw
⚠ ★★	2	2SA1104/A/-O* (2SA1104/A/-P*) (2SA1104/A/-Y*)	Q3, Q4
⚠ ★★	3	2SC2579/A/-O* (2SC2579/A/-P*) (2SC2579/A/-Y*)	Q1, Q2
	4	AEC-818	Insulating sheet
	11		Heat sink

*The hfe value of Q1, Q3 and Q2, Q4 must be the same.

6. SCHEMATIC DIAGRAM

NOTE:
The indicated manufacturers are representative only.
Other alternative manufacturers may be used and
are listed in the parts list.

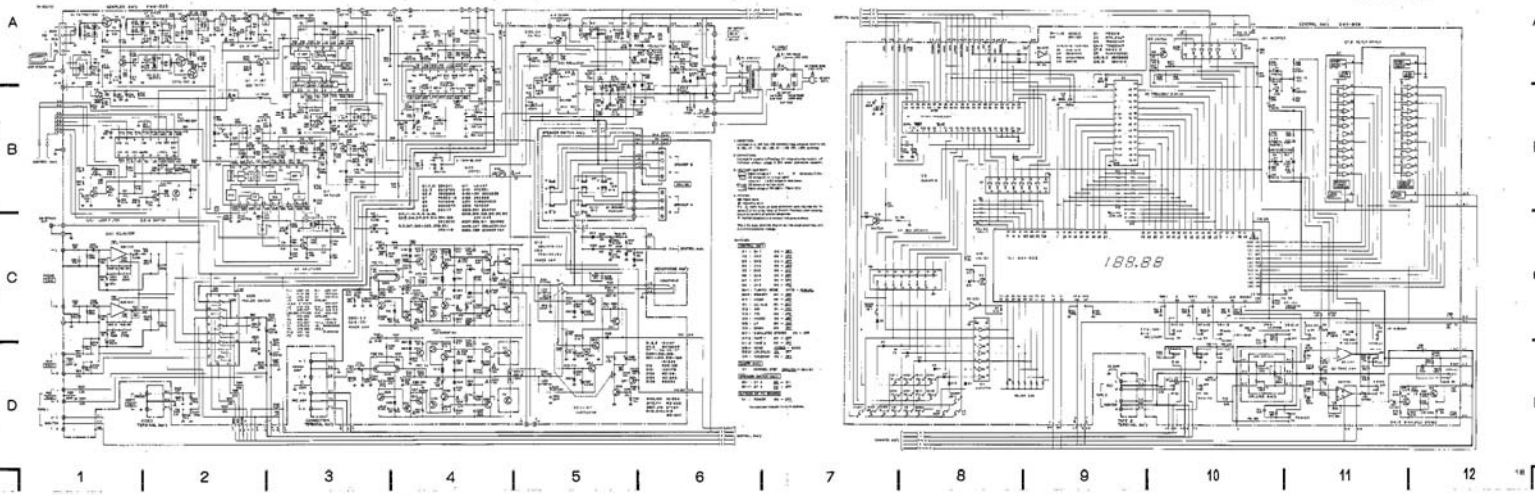

External Appearances of Transistors and IC's

**2SA992
2SC1845**

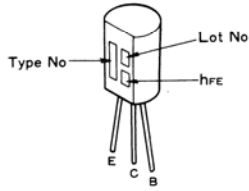

**2SA965/A/
2SC2235/A/**

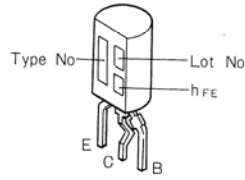

TD6301AP

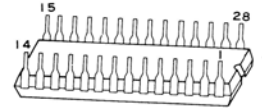

**2SA968
2SC2238**

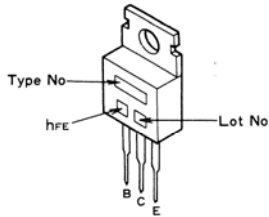

2SC2668

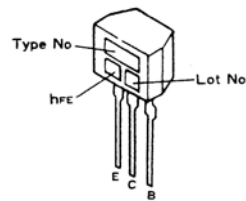

M5230L

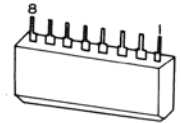

2SK241

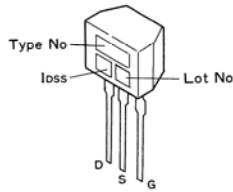

2SC2786

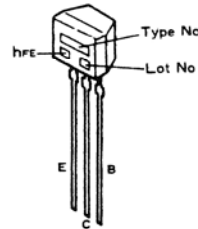

LA1247

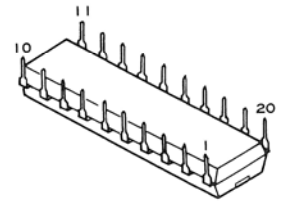

2SA798

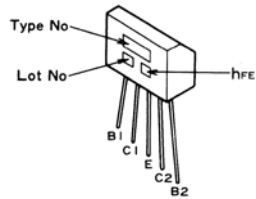

PA4008

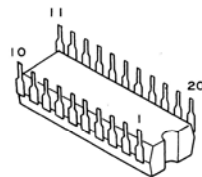

2SK117

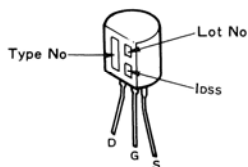

**HA12010
HA12016
M54927P
M74LS42P
TD62504P
PA3001-A**

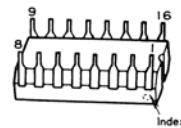

**2SA1104/A/
2SC2579/A/**

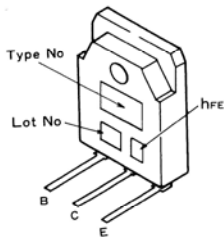

**NJM4558DX
NJM2043DD**

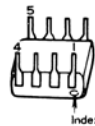

**2SA1115
2SC2603**

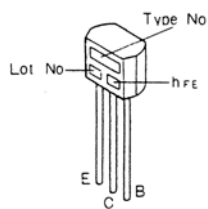

PD6019

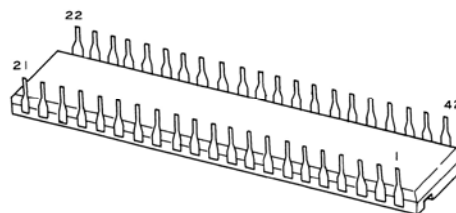

7. ELECTRICAL PARTS LIST

NOTES:

• When ordering resistors, first convert resistance values into code form as shown in the following examples.

Ex. 1 When there are 2 effective digits (any digit apart from 0), such as 560 ohm and 47k ohm (tolerance is shown by J=5%, and K=10%).

560Ω 56 × 10¹ 561... RD4PS $\frac{560}{10}$ J
 47kΩ 47 × 10³ 473... RD4PS $\frac{47000}{10}$ J

0.5Ω 0R5 RN2H $\frac{0500000000}{10}$ K
 1Ω 010 RS1P $\frac{1000000000000000}{10}$ K

Ex. 2 When there are 3 effective digits (such as in high precision metal film resistors).

5.62kΩ 562 × 10¹ 5621... RN4SR $\frac{5621000000000000}{10}$ F

• The $\frac{\Delta}{\Delta}$ mark found on some component parts indicates the importance of the safety factor of the part. Therefore, when replacing, be sure to use parts of identical designation.

• For your Parts Stock Control, the fast moving items are indicated with the marks ** and *.

** GENERALLY MOVES FASTER THAN *

This classification shall be adjusted by each distributor because it depends on model number, temperature, humidity, etc.

Miscellaneous

P.C. BOARD ASSEMBLIES

Mark	Part No.	Symbol & Description
	GWM-303	Complex assembly
	GWX-909	Control assembly
	non supply	Speaker switch assembly
	non supply	Headphone jack assembly
	non supply	Video terminal assembly
	non supply	Connection terminal assembly
	non supply	Volume assembly
	non supply	Tape terminal assembly

OTHERS

Mark	Part No.	Symbol & Description
*	ATS-017	T1 Power transformer (120V)
Δ	AEK-125	FU1 Fuse (4A)
Δ	** 2SA1104/A/-Q*	Q3, Q4
	(2SA1104/A/-P*)	
	(2SA1104/A/-Y*)	
Δ	** 2SC2579/A/-Q*	Q1, Q2
	(2SC2579/A/-P*)	
	(2SC2579/A/-Y*)	
*The life values of Q1, Q3 and Q2, Q4 must be same.		
Δ	** ASG-541	S1 Push switch (POWER)
	(ASG-539)	
Δ	ACG-502	C1 Ceramic (0.01/AC 125V)
	CKDYF473Z50	C2, C3
	ACN-147	R1 Wire wound (75/10W)
Δ	AKP-039	AC socket
	ADG-073	AC power cord
Δ	AKM-041	Connection plug
	AKB-076	Terminal (AM STEREO)

Complex Assembly (GWM-303)

SEMICONDUCTORS

Mark	Part No.	Symbol & Description
**	PA3001-A	Q7
**	MA12016	Q8
**	M54927P	Q9
**	NJM2043DD	Q201
**	PA4008	Q202
Δ	** M5230L	Q101
**	LA1247	Q17
**	2SC2235/A/	Q326, Q327
**	2SA965/A/	Q328, Q329
**	2SA798	Q303, Q304
**	2SA968	Q105
**	2SC2238	Q102 - Q104
**	2SK117	Q12
**	2SA992	Q307, Q308, Q311
**	2SA1115	Q13, Q317, Q320 - Q323, Q330, Q331
**	2SK241	Q1, Q4, Q21
**	2SC1845	Q306, Q306, Q309, Q310, Q312, Q315
**	2SC2786	Q2, Q5
**	2SC2668	Q3, Q6
**	2SC2603	Q10, Q11, Q14, Q15, Q18, Q19, Q20, Q313, Q314, Q316, Q318, Q319, Q324, Q325

Mark	Part No.	Symbol & Description	Mark	Part No.	Symbol & Description
*	STV2H	D307, D310		CCDSL 470J 50	C215, C216
*	1SV147	D1 - D3		CCDSL 150K 500	C305, C317
*	SVC321SP	D4 - D5		CCDSL 101D 500	C307, C308, C319, C320
*	10E2FD	D101		CCDSL 030C 50	C13, C83
Δ	R8602	D106		CCDSL 221J 50	C25
*	D5, 1 EB	D12		CCDSL 100D 50	C336, C337
*	(HZ5, 1 EB)			CKDYF 103Z 50	C4, C7, C8, C14, C15, C17, C24, C33, C53, C56, C62, C65, C72, C75 - C77, C79, C80, C82, C88
*	MZ-240 (WZ-240)	D106			
*	MZ-061 (WZ-061)	D104		CKDYB 472K 50	C309, C310
Δ	MZ-320 (WZ-320)	D110, D111		CKDYF 223Z 50	C3
*	MZ-047	D112, D315 - D318		CKDYF 473Z 50	C9, C20, C21, C23, C29, C60, C113, C225, C226, C312, C324
Δ	1S1564	D108, D109		CKDYB 102K 50	C34, C54, C70, C207, C214
*	1S1555 (US1035)	D6 - D11, D102, D103, D107, D301 - D305, D308, D311 - D314, D319 - D325		CKDYB 182K 50	C335
				CKDYB 222K 50	C67
				CKDYB 332K 50	C22, C35
				CKDYB 471K 50	C303, C315
				CKDYX 473M 25	C27, C38, C64, C66, C71, C87, C116
				ACG-019	C114 ceramic (0.01/AC 150V)

SWITCHES

Mark	Part No.	Symbol & Description
*	ASR-107	RL1 Relay
**	ASH-034	S1 Slide switch (CHANNEL STEP)

COILS AND TRANSFORMERS

Mark	Part No.	Symbol & Description	Mark	Part No.	Symbol & Description
	ATC-192	L1 FM antenna coil		CCPSL 220J 50	C331 - C334
	ATC-193	L2 FM antenna coil		QCSA 391J 50	C28
	ATC-194	L3 FM RF coil		QCSA 471J 50	C40, C41
	ATH-049	L4, L6, L8 AF choke coil		QCSA 102J 50	C51
	ATH-105	L5 FM oscillator coil		ACM-015	TC2, TC3
	ATH-087	L7 AM antenna coil		CEA 4R7M 50L	C32, C39
	ATH-053	L301, L302 AF choke coil		CEA 3R3M 50L	C48, C50
	ATE-053	T1 FM coupling transformer		CEA 100M 50L	C329, C330, C115
	ATB-091	T2 AM detection transformer		CEA 100M 16L	C44, C45, C69, C74, C86, C88, C112
	ATE-057	T3 FM coupling transformer		CEA 010M 50L	C26, C49, C63
	ATB-073	T4 AM oscillator coil		CEA 220M 25L	C36, C37, C89, C90
	ATB-093	T5 AM IFT coil		CEA R47M 50L	C19, C110
	ATF-145	F1, F2 FM ceramic filter		CEA 101M 25L	C52, C57, C84, C101, C104, C105, C304, C316, C326
	ATF-143	F3 AM ceramic filter		CEA 2R2M 50L	C31, C91, C111, C217, C224
				CEA 470M 25L	C61, C328
				CEA 470M 50L	C108, C109
				CEA 471M 6L	C203, C210
				CEA R68M 50L	C65
				CEA 0R1M 50L	C306, C311
	CCDRH 390J 50	C1, C2, C5, C6		CEA 221M 10L	C102
	CCDCH 160J 50	C18, C30		CEA 101M 35L	C103
	CCDCH 330J 50	C46		CEANL 2R2M 50	C202, C206, C209, C213, C301, C329, C327
	CCDCH 100D 50	C47		ACH-257	C106, C107 electrolytic (8200/50)
	CCDCH 220J 50	C58, C59			
	CCDTH 180J 50	C81			
	CCDCH 180D 50	C92			
	CCDSL 050C 50	C11, C78			
	CCDSL 101J 50	C12, C201, C208, C222, C223			
	CCDSL 020C 50	C10			

CAPACITORS

Mark	Part No.	Symbol & Description
	CCDRH 390J 50	C1, C2, C5, C6
	CCDCH 160J 50	C18, C30
	CCDCH 330J 50	C46
	CCDCH 100D 50	C47
	CCDCH 220J 50	C58, C59
	CCDTH 180J 50	C81
	CCDCH 180D 50	C92
	CCDSL 050C 50	C11, C78
	CCDSL 101J 50	C12, C201, C208, C222, C223
	CCDSL 020C 50	C10

RESISTORS

NOTE: When ordering resistors, convert the resistance value into code form, and then rewrite the part no. as before.

Mark	Part No.	Symbol & Description
	RS3LF 750J	R106
△	RD1/4PMFL □□□J	R117, R311, R359 – R362, R367 – R370
△	RD1/4PMF □□□J	R8, R23, R42, R71, R118, R119, R312, R321, R322
	RD1/2PSF100J	R325 – R328
	RD1/4PMF □□□J	R309, R310, R319, R320
	RS1LF □□□J	R112 – R114, R331, R332, R342
	RS1L 271J	R100
	RD1/4PM 471J	R107
	RD1/8PM □□□J	Other resistors
	ACN-140	R110 Carbon compound (2.2M/1/2W)
	ACN-131	R375, R376 Wire wound (0.22 x 2/2W)
★	RHB8AVS502-T	VR1 5k (VCO adj)
★	RHB8AVS101-T	VR2, VR3 100 (Idle adj)
	TH103-2	TH1, TH2

OTHERS

Mark	Part No.	Symbol & Description
	AKX-078	Complex terminal (SPEAKERS, ANTENNA, TAPE1, CD/AUX)
	AKB-093	Terminal (PHONO)
★	ASS-018	X1 Crystal resonator
	AKH-017	Transistor socket
	PBZ30P060 FMC	Screw (3 x 6)

Speaker Switch Assembly

Mark	Part No.	Symbol & Description
★★	SUL8LYZSF	S2 Push switch (SPEAKERS)

Headphone Jack Assembly

Mark	Part No.	Symbol & Description
	AKN-045	Headphone jack (PHONES)

Video Terminal Assembly

Mark	Part No.	Symbol & Description
	AKB-098	Terminal (VIDEO L/MONO)
	AKB-102	Terminal (VIDEO R)

Connection Terminal Assembly

Mark	Part No.	Symbol & Description
	AKB-094	Terminal (PRE AMP, POWER AMP)

Control Assembly (GWX-909)

SEMICONDUCTORS

Mark	Part No.	Symbol & Description
★★	PD6019	Q1
★★	M74LS42P	Q2
★★	TD6301AP	Q3
★★	TD62504P	Q4 – Q6
★★	HA12010	Q7, Q8
★★	NJM4558DX	Q9
★★	2SC2603	Q10, Q14, Q15
★★	2SA1115	Q12, Q13
★	MZ-130 (WZ-130) (RD13EB) (HZ13EB)	D12
★	1S1555 (US1035)	D1 – D11, D13

SWITCHES

Mark	Part No.	Symbol & Description
★★	ASG-704	S1 – S8, S10 – S16 Tact switch (STATION CALL, FUNCTION, UP, DOWN)
★★	ASG-816	S9 Push switch (TUNING MODE, MEMORY)
★★	SEA6V441S	S17 Push switch (TAPE1, TAPE2/ADAPTOR, SIMULATED STEREO)
★★	SEA5V2BB3S	S18 Push switch (LOUDNESS/MONO)
★★	SEAV3S	S19 Push switch (SUBSONIC)

CAPACITORS

Mark	Part No.	Symbol & Description
	CEJA 101M 6	C2, C8, C31, C32, C37
	CEJA R22M 50	C11, C12
	CEJA R33M 50	C17, C18
	CEJA R47M 50	C26, C25
	CEJA 010M 50	C13, C14
	CEJA 2R2M 50	C27, C30
	CEJA 100M 16	C23, C24, C33, C34
	CEJA 220M 16	C9, C10, C19, C20
	CKDYB 331K 50	C4, C5
	CKDYB 182K 50	C38
	CKDYB 102K 50	C39
	CCDSL 151J 50	C35, C36
	CQSA 331J 50	C29
	CQMLA 103J 50	C21, C22
	CQMLA 332J 50	C28
	CQMLA 273J 50	C15, C16

RESISTORS

NOTE: When ordering resistors, convert the resistance value into code form, and then rewrite the part no. as before.

Mark	Part No.	Symbol & Description
★	ACX-122 RD1/4PM □□□J RD1/8PM □□□J	VR1, VR2 10k (BASS, TREBLE) R60, R62, R63 Other resistors

OTHERS

Mark	Part No.	Symbol & Description
★	AAV-022	FL tube
★	ASS-017	X1 Ceramic resonator

Volume Assembly

Mark	Part No.	Symbol & Description
★	ACT-210	VR3 100k x 2, 50k (VOLUME, BALANCE)

Tape Terminal Assembly

Mark	Part No.	Symbol & Description
	AKB-094	Terminal (TAPE2/ADAPTOR)

8. PACKING

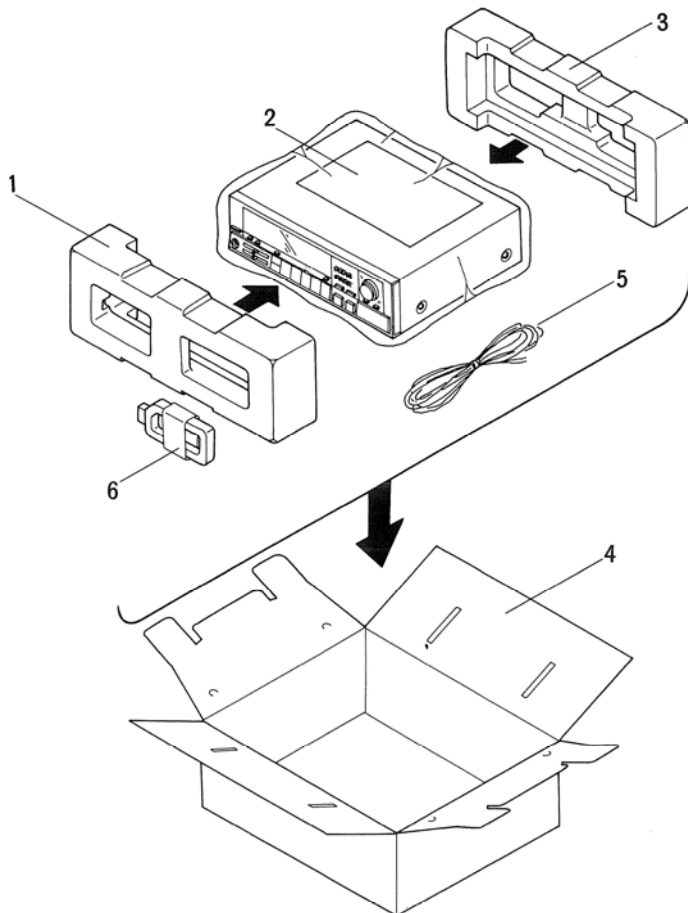

Parts List

Mark	No.	Part No.	Description
	1	AHA-348	Front pad
	2	ARB-556	Operating instructions (English)
	3	AHA-349	Rear pad
	4	AHE-204	Packing case
	5	ADH-005	FM antenna
	6	ATB-086	Loop antenna

9. ADJUSTMENT

FM Tuner Section

- Connect the FM SG to FM 300Ω antenna terminal through a 300Ω dummy antenna.
- Set FUNCTION to FM, and TUNING MODE to MANUAL.

Step	FM SG (400 Hz, ± 75kHz dev.)		SX-50 frequency display	Adjustment point	Adjustment procedure
	Frequency	Level			
1	No signal		108.00MHz	—	Confirm that DC voltage between TP12 and ground is $8.7 \pm 2V$
2			87.50MHz	—	Confirm that DC voltage between TP12 and ground is $3.4 \pm 1.5V$
3	98.000MHz*	60dB	98.00MHz	L3, T1	Adjust until DC voltage between TP11 and ground is maximum
4				T3 (CENTER)	Adjust until DC voltage between TP8 and TP9 is 0V.
5				T3 (DIST)	Minimize the distortion at REC1 terminal
6	Repeat steps 4 ~ 5 until requirements are satisfied				

* Frequency must be accurate

FM MPX Section

- Connect the FM multiplex stereo signal generator to the FM SG external modulation terminal.
- Set the output of the FM SG to 98.000MHz (with modulation mode set to external) and tune SX-50 to the frequency (98.00MHz).

Step	FM MPX SG		Adjustment point	Adjustment procedure
	MODULATION	LEVEL		
1	No modulation	60dB	VR1	Adjust signal at TP1 to 76kHz
2	Main (1kHz, L + R, ± 67.5kHz dev.) Pilot (19kHz, ± 7.5kHz dev.)	86 dB	T1 within ± 90°	Minimize the distortion at REC1 terminal
3	—	below 30dB	—	Confirm that STEREO ind. is not illuminated

AM Tuner Section

- Set FUNCTION to AM, TUNING MODE to MANUAL position, CHANNEL STEP to 9kHz position.

Step	AM SG (400 Hz, 30% MOD.)		SX-50 frequency display	Adjustment point	Adjustment procedure
	Frequency	Level			
1	No signal		522kHz	T4	Adjust until DC voltage between TP12 and ground is $1.2 \pm 0.1V$
2			1620kHz	TC2	Adjust until DC voltage between TP12 and ground is $10V \pm 0.2V$
3	Repeat steps 1 and 2 until the required voltage is attained				
4	603kHz	60dB	603kHz	L7	Adjust until voltage between TP38 and ground is maximum.
5	1395kHz	60dB	1395kHz	TC3	
6	Repeat steps 4 and 5 until maximum voltage is attained.				

Amplifier Section

1. Turn the VOLUME to minimum.
2. Set the SPEAKER A switch to ON.
3. Adjust VR2 until DC voltage between TP19 and SPEAKER A L ⊕ terminal is 5mV.
4. Adjust VR3 until DC voltage between TP18 and SPEAKER A R ⊕ terminal is 5mV.

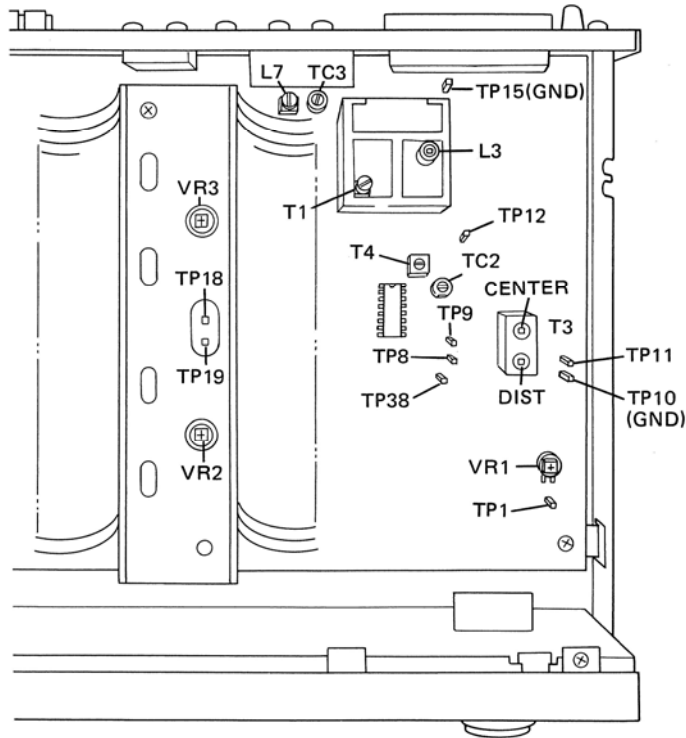

Adjusting Points

9. RÉGLAGE

Partie syntonisation FM

- Relier le générateur de signal FM sur la borne 300 ohms de l'antenne FM en intercalant une antenne fictive de 300 ohms.
- Placer le commutateur FUNCTION sur la position FM, et le mode de syntonisation (TUNING MODE) sur manual (MANUAL).

Phase	FM SG (400Hz, ± 75 kHz de déviation)		Affichage fréquence SX-50	Point de réglage	Méthode de réglage
	Fréquence	Niveau			
1	Pas de signal		108,00MHz	—	S'assurer que la tension CC entre TP12 et la terre est de $8,7 \pm 2V$.
2			87,50MHz	—	S'assurer que la tension CC entre TP12 et la terre est de $3,4 \pm 1,5V$.
3	98,000MHz*	60dB	98,000MHz	L3, T1	Continuer à régler jusqu'à ce que la tension entre TP11 et la terre soit maximale.
4				T3 (CENTER)	Continuer à régler jusqu'à ce que la tension CC entre TP8 et TP9 soit de 0V.
5				T3 (DIST)	Réduire la distortion au minimum au niveau de la borne REC 1.
6	Recommencer 4~5 jusqu'à ce que les spécifications soient remplies.				

* La fréquence doit être précise

Partie FM MULTIPLEX

- Brancher le générateur de signal multiplex FM stéréo sur la borne de modulation externe du modulateur de signal FM.
- Régler la sortie du générateur de signal FM sur 98,000MHz (le mode de modulation étant sur externe), et régler le SX-50 sur la fréquence 98,000MHz.

Phase	FM MPX SG		Point de réglage	Méthode de réglage
	MODULATION	NIVEAU		
1	Pas de modulation	60dB	VR1	Régler le signal au niveau du TP1 sur 76kHz.
2	Principal (1kHz, D+G, déviation de $\pm 67,5$ kHz) Pilote (19kHz, déviation de $\pm 7,5$ kHz)	86dB	T1 entre $\pm 90^\circ$	Réduire la distortion au minimum au niveau de la borne REC 1.
3	—	inférieur à 30dB	—	S'assurer que le témoin STEREO n'est pas allumé.

Partie syntonisation AM

- Placer le commutateur FUNCTION sur AM, le mode de syntonisation sur manuel (MANUAL), et le sélecteur de canal (CHANNEL STEP) sur la position 9kHz.

Etapas	AM SG (400Hz, modulation de 30%)		Affichage fréquence SX-50	Point de réglage	Méthode de réglage
	Fréquence	Niveau			
1	Pas de signal		522kHz	T4	Continuer à régler jusqu'à ce que la tension CC entre TP12 et la terre soit de $1,2 \pm 0,1V$.
2			1620kHz	TC2	Continuer à régler jusqu'à ce que la tension CC entre TP12 et la terre soit de $10V \pm 0,2V$.
3	Recommencer 1 et 2 jusqu'à ce que la tension voulue soit atteinte.				
4	603kHz	60dB	603kHz	L7	Continuer à régler jusqu'à ce que la tension entre TP38 et la terre soit maximale.
5	1395kHz	60dB	1395kHz	TC3	
6	Recommencer 4 et 5 jusqu'à ce que la tension maximale soit atteinte.				

Partie amplificatrice

1. Régler la volume (VOLUME) au minimum.
2. Placer le commutateur du haut-parleur A sur marche (ON).
3. Régler VR2 afin que la tension entre TP18 et la borne \oplus gauche (L) du haut-parleur A soit de 5mV.
4. Régler VR3 afin que la tension entre TP19 et la borne \oplus droit (R) du haut-parleur A soit de 5mV.

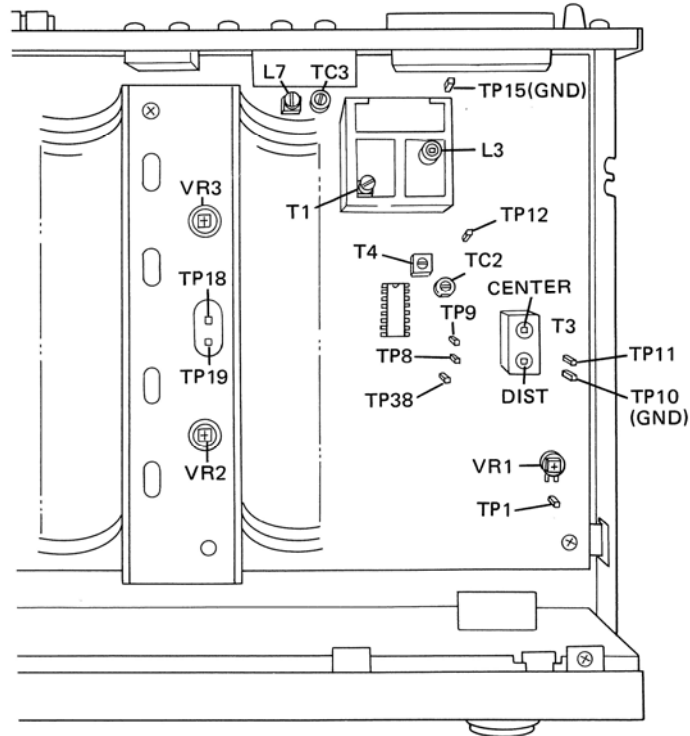

Points de réglage

9. AJUSTE

Sección del sintonizador de FM

- Conectar el generador de señales de FM (FM SG) al terminal de antena de FM de 300 ohmios a través de una antena ficticia de 300 ohmios.
- Poner el selector FUNCTION en FM y el de TUNING MODE en la posición MANUAL.

Paso	FM SG (400Hz, ± 75 kHz de desv.)		Frecuencí- metro del SX-50	Punto de ajuste	Procedimientos de ajuste
	Frecuencia	Nivel			
1	Sin señal		108,00MHz	—	Confirmar que la tensión de CC entre TP12 y masa sea de $8,7 \pm 2V$.
2			87,50MHz	—	Confirmar que la tensión de CC entre TP12 y masa sea de $3,4 \pm 1,5V$.
3	98,000MHz*	60dB	98,00MHz	L3, T1	Ajustar hasta que la tensión de CC entre TP11 y masa sea la máxima.
4				T3 (CENTER)	Ajustar hasta que la tensión de CC entre TP8 y TP9 sea de 0V.
5				T3 (DIST)	Minimizar la distorsión en el terminal REC 1.
6	Repetir los pasos 4 al 5 hasta que se satisfagan los requisitos.				

* La frecuencia debe ser precisa.

Sección de multiplex de FM (FM MPX)

- Conectar un generador de señales estereofónicas de multiplex de FM al terminal de modulación exterior del FM SG.
- Ajustar la salida del FM SG a 98,000MHz (con el modo de modulación ajustado al exterior y sintonizar el SX-50 a la frecuencia (98,000MHz).

Paso	FM MPX SG		Punto de ajuste	Procedimientos de ajuste
	MODULACION	NIVEL		
1	Sin modulación	60dB	VR1	Ajustar la señal en TP1 a 76kHz.
2	Principal (1kHz, L+R, $\pm 67,5$ kHz de desv.) Piloto (19kHz, $\pm 7,5$ kHz de desv.)	86dB	T1 dentro de $\pm 90^\circ$	Minimizar la distorsión en el terminal REC 1.
3	—	por debajo de 30dB	—	Confirmar que el indicador STEREO no esté iluminado.

Sección del sintonizador de AM

- Poner el selector FUNCTION en AM, el de TUNING MODE en MANUAL y el de CHANNEL STEP en la posición de 9kHz.

Paso	AM SG (400Hz, 30% de mod.)		Frecuencí- metro del SX-50	Punto de ajuste	Procedimientos de ajuste
	Frecuencia	Nivel			
1	Sin señal		522kHz	T4	Ajustar hasta que la tensión de CC entre TP12 y masa sea de $1,2 \pm 0,1V$.
2			1620kHz	TC2	Ajustar hasta que la tensión de CC entre TP12 y masa sea de $10V \pm 0,2V$.
3	Repetir los pasos 1 y 2 hasta que se obtenga la tensión requerida.				
4	603kHz	60dB	603kHz	L7	Ajustar hasta que la tensión entre TP38 y masa sea la máxima.
5	1395kHz	60dB	1395kHz	TC3	
6	Repetir los pasos 4 y 5 hasta obtenerse la tensión máxima.				

Sección del amplificador

1. Girar el control VOLUME a la posición mínima.
2. Poner el selector de SPEAKER A en ON.
3. Ajustar VR2 hasta que la tensión de CC entre TP18 y SPEAKER A L (+) sea de 5mV.
4. Ajustar VR3 hasta que la tensión de CC entre TP19 y SPEAKER A R (+) sea de 5mV.

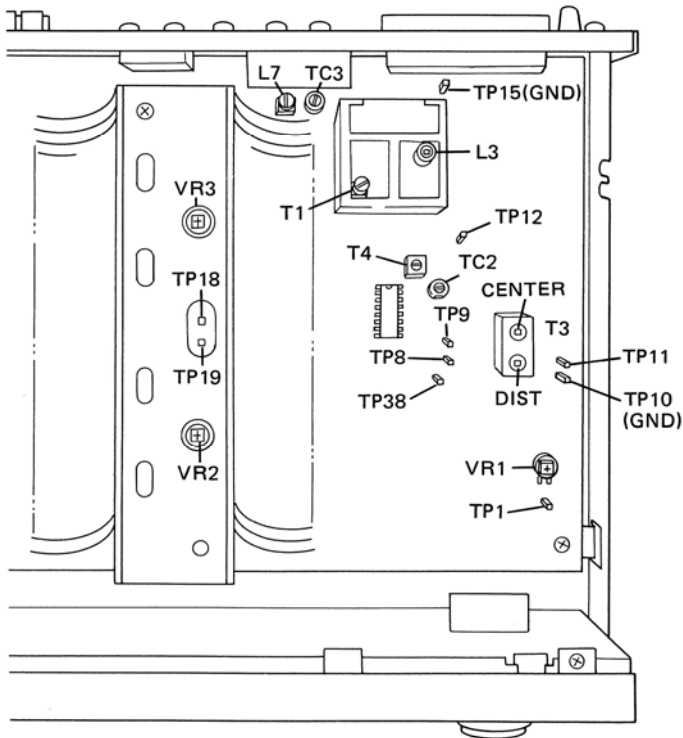

Puntos de ajuste

10. SAFETY INFORMATION

1. SAFETY PRECAUTIONS

The following check should be performed for the continued protection of the customer and service technician.

LEAKAGE CURRENT CHECK

Measure leakage current to a known earth ground (water pipe, conduit, etc.) by connecting a leakage current tester such as Simpson Model 229-2 or equivalent between the earth ground and all exposed metal parts of the appliance (input/output terminals, screwheads, metal overlays, control shaft, etc.). Plug the AC line cord of the appliance directly into a 120V AC 60Hz outlet and turn the AC power switch on. Any current measured must not exceed 0.5mA.

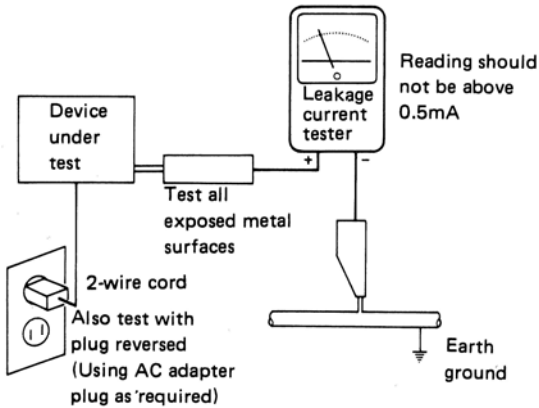

AC Leakage Test

ANY MEASUREMENTS NOT WITHIN THE LIMITS OUTLINED ABOVE ARE INDICATIVE OF A POTENTIAL SHOCK HAZARD AND MUST BE CORRECTED BEFORE RETURNING THE APPLIANCE TO THE CUSTOMER.

2. PRODUCT SAFETY NOTICE

Many electrical and mechanical parts in the appliance have special safety related characteristics. These are often not evident from visual inspection nor the protection afforded by them necessarily can be obtained by using replacement components rated for voltage, wattage, etc. Replacement parts which have these special safety characteristics are identified in this Service Manual.

Electrical components having such features are identified by marking with a ⚠ on the schematics and on the parts list in this Service Manual.

The use of a substitute replacement component which does not have the same safety characteristics as the PIONEER recommended replacement one, shown in the parts list in this Service Manual, may create shock, fire, or other hazards.

Product Safety is continuously under review and new instructions are issued from time to time. For the latest information, always consult the current PIONEER Service Manual. A subscription to, or additional copies of, PIONEER Service Manual may be obtained at a nominal charge from PIONEER.